

Rowenta

Steam 'n Press

Instructions for Use

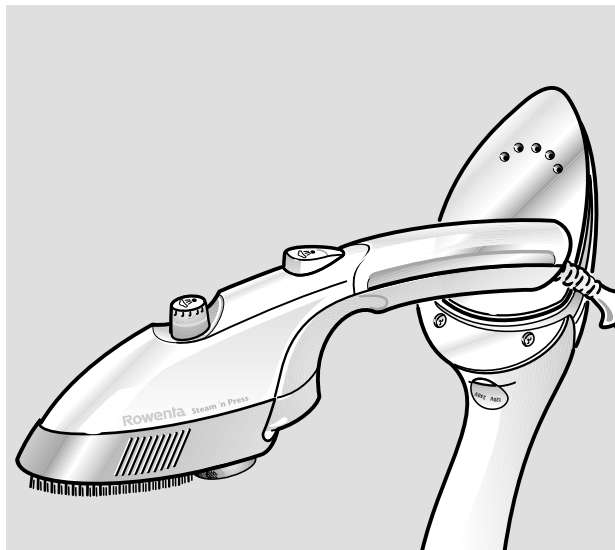

REF. 3460984

IMPORTANT SAFETY INSTRUCTIONS

When using your Rowenta Steam 'n Press basic precautions should always be followed, including the following:

Read all instructions before using the appliance.

1. Use appliance only for its intended use.
2. To protect against a risk of electric shock, **do not** immerse the appliance in water or other liquids. Do not use the appliance in a wet environment (on a wet floor, near a sink).
3. The appliance should always be turned to Minimum (Min) before plugging or unplugging from outlet. Never yank cord to disconnect from outlet, instead grasp plug and pull to disconnect.
4. Do not allow cord to touch hot surfaces. Let appliance cool completely before putting away. Loop cord loosely around appliance when storing.
5. Always disconnect appliance from electrical outlet when filling appliance with water, emptying appliance or when not in use.
6. Do not operate appliance with a damaged cord or if the appliance has been dropped or damaged. To avoid the risk of electric shock, do not disassemble the appliance, ship it to the nearest authorized Rowenta Appliance Service Center for examination and repair. Incorrect reassembly can cause a risk of electric shock when the appliance is used.
7. This appliance is not a toy, so close supervision is necessary for any appliance being used by or near children. Do not leave appliance unattended while plugged in or on an ironing board.
8. Burns can occur from touching hot metal parts, hot water, steam or hot soleplate cover.
9. The use of accessory attachments not recommended by Rowenta may result in fire, electric shock or personal injury.
10. Be sure dual voltage selector is in correct voltage position before operating. Before plugging in, read the information about dual voltage operation in the instruction section of this manual.

SPECIAL INSTRUCTIONS

1. This is a 1000 watt appliance. To avoid a circuit overload, do not operate a high wattage appliance on the same circuit.
2. If an extension cord is absolutely necessary, a 10-ampere cord should be used. Cords rated for less amperage may overheat. Care should be taken to arrange the cord so that it cannot be pulled or tripped over.
3. Your Rowenta appliance is intended for household use only.
4. **IMPORTANT** – Do not remove soleplate cover when appliance is hot. Turn thermostat to minimum and allow unit to cool. Always remove carefully and avoid touching soleplate which will remain hot for some time. Refer to full operating instructions.

SAVE THESE INSTRUCTIONS

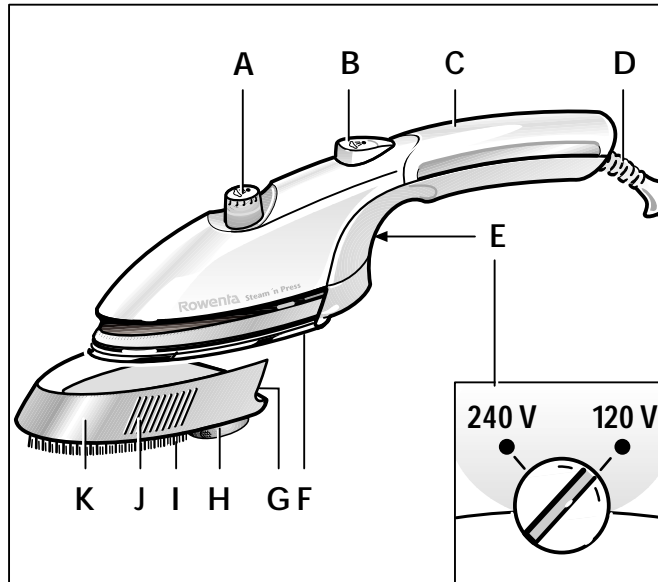

■ **Description:**

- | | |
|--------------------------------|------------------------|
| A Thermostat control dial | G Soleplate cover lock |
| B Burst of steam button | H Lint pad |
| C Removable water tank | I Fabric brush |
| D Cord protector | J Ribbed finger grip |
| E Voltage selector (120/240 V) | K Soleplate cover |
| F Polished soleplate | |

USING FOR THE FIRST TIME

- Please read the instructions for use and the **Important Safety instructions** carefully.
- It is normal for a small amount of smoke to be produced the first time the appliance is used. This will quickly disappear.

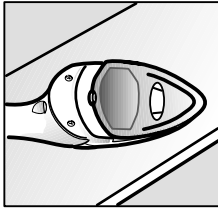

- When the appliance is plugged in, and thermostat control dial is moved from the minimum setting, the soleplate heats. Do not touch or remove the soleplate cover without letting the appliance cool down.
- During use or while unit is heating or cooling, do not rest appliance on its soleplate. Place product on its side on a firm, heat resistant, flat surface, as soleplate will be hot.

- As the appliance heats the housing becomes warm. This is normal.

DUAL VOLTAGE

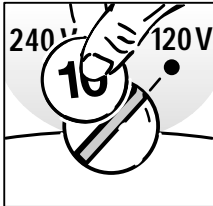

Dual voltage selection

- The appliance can work on both, 120V or 240V, AC systems.
- Be sure the dual voltage selector (E) is in the correct voltage position before operating. To do this, unplug the appliance and turn the selector which is below the handle with a coin, so it is aligned with the correct voltage (either 120V or 240V).

 Never change selector while unit is plugged in.

- This is a 120/240 V dual voltage appliance and may be used in the United States and abroad without an electricity converter. An adapter plug may be necessary when using appliance in foreign countries. If needed, plug the steambrush into correct adapter plug for the specific country and plug assembly into electrical outlet.

Dual voltage selector in wrong position

- If the voltage selector is set to 240 V in a 120 V supply, the performance of the Steambrush will be reduced.
- Never set the voltage selector to 120 V in a 220–240 V supply, as this can damage the product.

FILLING THE WATER TANK

Before plugging in the Steam 'n Press fill the water tank (C) with water as follows:

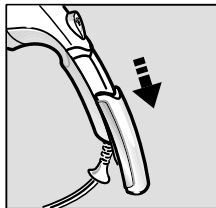

Remove the water tank

- To remove the water tank, hold on to the bottom half of the handle and slide the top half of the handle away from the appliance as shown.

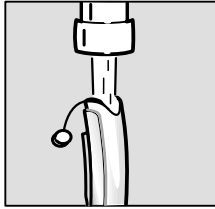

Filling the water tank

- Remove cap, fill the tank with ordinary tap water and close the cap.

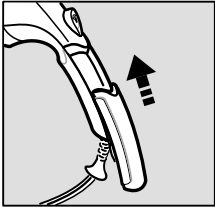

Replacing the water tank

- Put the full water tank back into the unit, by sliding the lower handle back into the top half of the handle until it is firmly in place.

Adding water during use

- Always unplug the appliance and wait for it to cool down before removing the water tank.
- Handle with care as unit will remain hot for a considerable time.
- Fill as indicated in water tank filling section.
- Plug in the appliance and wait approximately one minute to ensure your Steam 'n Press is fully reheated before using it.

ATTACHING AND REMOVING THE SOLEPLATE COVER

Attaching the soleplate cover

The Steam 'n Press should be unplugged and completely cool when removing or attaching the soleplate cover.

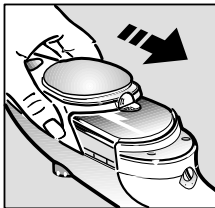

- To attach the soleplate cover (K) to the Steam 'n Press, hold the soleplate cover by the ribbed finger grips (J) and slide the cover over the soleplate.

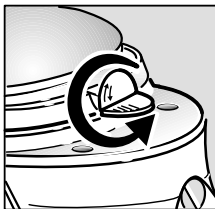

- Turn the soleplate cover lock (G) half a turn (180°) to the left to lock the soleplate cover into position.

- Your appliance can be used as a Steambrush once cover is attached. Reference "Steambrush Function" section of instructions for further use information.

Removing the soleplate cover

The steambrush should be unplugged and completely cool when removing or attaching the soleplate cover.

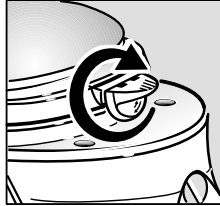

- To remove the soleplate cover (K) turn the soleplate cover lock (G) a half turn (180°) to the right.

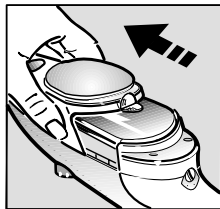

- Grip the soleplate cover by the ribbed finger grips (J) on both sides as shown and pull towards the tip of unit to remove.

- Reference "Ironing Function" section of instructions for further use information.

IRONING FUNCTION

The soleplate of the Steam 'n Press will smooth out tough wrinkles from clothes and press in sharp creases and pleats.

Starting up



Before plugging in please remove cover. When the Steam 'n Press is plugged in the soleplate heats. Do not touch or remove the soleplate cover without letting the soleplate cool down.

- Remove the soleplate cover as indicated in instructions called "Removing the Soleplate Cover".

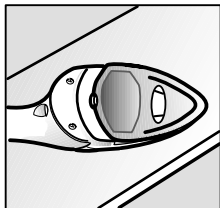

- Plug in the appliance, place it on its side and wait approximately one minute for it to reach full temperature before using.
- During use or while unit is heating or cooling, do not rest it on its soleplate. Place product on its side on a firm flat surface, as it will be hot.



Never iron clothes while they are being worn.

Selecting the temperature

- Set the thermostat control dial (A) according to the type of fabric you are ironing. Check the fabric label for the appropriate setting.

Fabric	Temperature regulator
synthetics nylon polyester	● (low temperature)
silk wool	●● (medium temperature)
cotton linen	●●● (high temperature)

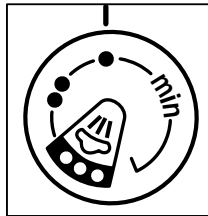

Start at low temperature ● and graduate to high temperature ●●●. For delicate fabrics we recommend carrying out a test on an unobtrusive part of the garment (inner seam). Steam can only be produced when the thermostat is aligned to ●●● setting.

STEAMBRUSH FUNCTION

Using for the first time

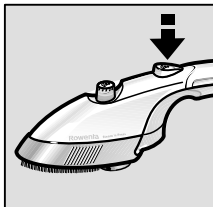
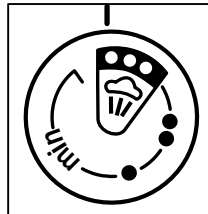

⚠ When the Steam 'n Press is plugged in the soleplate heats. Do not touch or remove the soleplate cover without letting the soleplate cool down.

- Make sure soleplate cover is securely in place before using the steambrush function. Please reference section in instructions called "Attaching the Soleplate Cover".
- Plug in your Steam 'n Press and set the thermostat to the ●●● steam setting.
- After approximately one minute it will reach working temperature.
- To begin steaming, press the burst of steam button 4 to 5 times to prime the unit.

NOTE: The Steam 'n Press can be used on virtually all articles of clothing in the home. Care should be taken when steaming heat sensitive synthetic materials such as nylon or rayon. We recommend you test acrylic, nylon or other synthetic fabrics on an unobtrusive area to ensure these fabrics are not damaged by hot steam.

To avoid damage to clothes from dust or dirt that may collect in the appliance, we recommend that before the first use or after the appliance has been stored for some time you test the burst of steam on an old cloth.

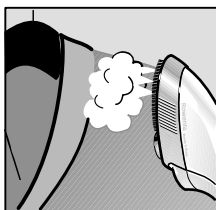

Steaming clothes

- Hang the wrinkled article of clothing on a clothes hanger.
- Pull the clothing tight with one hand and place the appliance over the creased area beginning at the top of garment.
- Gently press the fabric brush (I) against the clothing and move the appliance down over the fabric at the same time pressing the burst of steam (B) every 4 seconds.
- The combination of steam and the brush will gently remove the wrinkles.
- After treatment, let the article of clothing cool down on the hanger before wearing.

 Never steam clothes while they are being worn.

Steaming drapes and upholstery

- Wrinkles and creases can be removed from drapes while they are hanging on the rods.
- Simply follow the procedure described in "Steaming clothes".
- Always test first on unobtrusive area.
- When using the appliance horizontally return to the vertical position occasionally to ensure maximum steam performance.

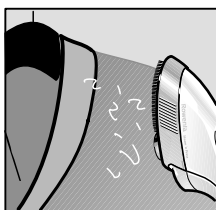

Lint pad

- Threads, lint and hair can easily be removed with the lint pad (H) by brushing the clothes slowly from left to right.
- The pad can be cleaned by brushing in the opposite direction right to left on a scrap of old cloth.

AFTER USING THE STEAMBRUSH

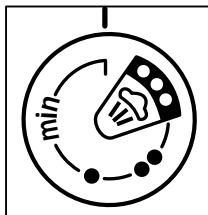

- Set the temperature control dial (A) to min. then unplug the appliance. Empty the water remaining in the tank and leave unit on its side to cool.

Storage

- After the appliance has cooled down, it may be stored in the bag provided.

CLEANING AND MAINTENANCE

If the body and the handle become dirty they should be wiped with a damp cloth when the appliance is cold and unplugged. Do not use abrasive or other chemicals.

Cleaning the soleplate

- In normal use a draggy coating may build up on the soleplate (starch, detergent buildup, burnt synthetic fibers). This can be easily removed by using the Rowenta Soleplate Cleaning Kit or a quality hot iron soleplate cleaner available at most stores.
- Do not use abrasive household cleaners or abrasive cleaning pads.
- To prevent scratching of the soleplate, do not iron over sharp objects (zippers, etc.). Do not place the appliance on rough surfaces, e.g. metal iron support, which may scratch the soleplate.

WATER TO USE IN ROWENTA STEAM 'N PRESS

Tap water

The Rowenta Steam 'n Press is designed to be used with REGULAR TAP WATER (up to 12 grains of hardness). If your water is harder than this, Rowenta recommends mixing half tap water with half distilled water which reduces the hardness; or just use inexpensive bottled spring water.

Never use 100% distilled water since this can cause the iron to spit and leak.

Softened water

There are many types of household water softeners and the water from many of them is perfectly acceptable for use in the Steam 'n Press. However, some types of softeners, particularly those that use chemicals such as salt, can cause the appliance to leak or spit during use. If you experience this type of problem, we recommend that you try using inexpensive bottled spring water or untreated tap water.

Never use 100% pure distilled water.

Once you have changed water it will take several uses to correct the problem. Rowenta recommends trying the steam function for the first time on an old towel or cloth to avoid damaging your clothes.

Iron and other impurities

If your water supply contains large amounts of iron or organic matter, these minerals can collect inside the appliance and eventually appear as brown stains. If you experience these problems, Rowenta recommends using inexpensive bottled spring water.

Never use 100% pure distilled water.

Always remember:

Battery water and water containing additives (such as starch, perfume or fabric conditioner) may not be used. Such additives can affect the properties of the steam and, at high temperatures, can form deposits in the steam chamber, which will mark the laundry when they are emitted through the steam vents. For this reason descaling liquids should not be used.

In the interest of improving products, Rowenta reserves the right to change specifications without prior notice.

STEAM 'N PRESS TROUBLE SHOOTING

Problem	Possible Cause	Solution
Leaking or spitting.	Distilled water.	Never use 100% distilled water. The Steam 'n Press is designed to use tap water. In very hard water areas we recommend using bottled spring water.
	Softened water.	If you experience spitting or leaking with softened water, change to untreated tap water or bottled spring water.
	Thermostat set incorrectly.	The thermostat needs to be set to the 3 dot setting to produce steam.
	Overuse of burst of steam.	Allow 4 seconds between each burst.
	Water tank.	Be sure that water tank is firmly in place.
	Isn't hot enough.	Allow Steam 'n Press to heat for approximately 1 minute before using.
Steam 'n Press won't heat.	Is it plugged in?	Check plug securely in socket.
	Is thermostat set too low?	Turn the thermostat to a higher setting.
Does not steam.	Is water in the tank?	Ensure tank has water in it.
	Burst button not primed.	Press the burst button 4-5 times to begin steaming.
Not enough power or too much	Dual voltage not set correctly.	Be sure the dual voltage selector is in correct voltage position before operating. Unplug the appliance and turn the selector (which is below the handle) with a coin to align it with the correct voltage (either 120 or 240 V).